

 plg grup

 poligon  
mühendislik  
Link To The Future

 PLG  
Engineering

 plg labs

## KURUMSAL TANITIM - 2024



[www.poligonmuhendislik.com](http://www.poligonmuhendislik.com)

## Hakkımızda



Temelleri 2013 yılında kurulan Poligon Mühendislik ile atılan **PLG Grup** çatısı altında; **Poligon Mühendislik**, **PLG Engineering** ve **PLG Labs** firmaları yer almaktadır.

PLG Grup, fikir aşamasından seri üretime kadar tüm ürün geliştirme çalışmalarını kendi bünyesinde çözebilecek güçlü bir altyapıya sahiptir. **HP**, **Scantech** ve **Stratasys** gibi dünyaca ünlü teknoloji markalarının Türkiye Yetkili Temsilcisi olan grup; sahip olduğu bu yetkinlikler ve yüksek teknoloji ile piyasaya ürün çıkarma konusunda müşterilerine en hızlı şekilde, en uygun maliyetle, en doğru çözümü sunmaktadır.



**PLG Grup ile  
Yarına Liderlik  
Etmeye Hazır Ol!**

 **plg grup**

 **plg grup**

 **poligon** mühendislik  
Link To The Future

 **PLG**  
Engineering

 **plg labs**

# PLG Grup Yapısı



Mühendislik Hizmetleri ve Üretim

Bursa  
İstanbul



Satış, Pazarlama ve Servis  
(HP, Scantech, Stratasys)

Bursa  
İstanbul



Mühendislik Hizmetleri ve Üretim

Nottingham,  
UK

+320.000 SAAT  
3D BASKI DENEYİMİ



+25.000 SAAT  
TERSİNE MÜHENDİSLİK  
DENEYİMİ



3 LOKASYONDA  
3.000 m2 KAPALI ALAN  
İstanbul & Bursa & Nottingham, UK



ÇÖZÜM ODAKLI  
MÜHENDİSLİK  
YAKLAŞIMI

MÜKEMMEL MÜŞTERİ DENEYİMİ  
7/24 MÜŞTERİ ÖNCELİĞİ

GÜVENİLİR  
MARKA İMAJI



3 SEÇKİN  
GLOBAL PARTNER



SERTİFİKALAR:  
ISO 9001: 2015  
AS 9100 REV. D  
EYDEP, JOSCAR, TUSAŞ



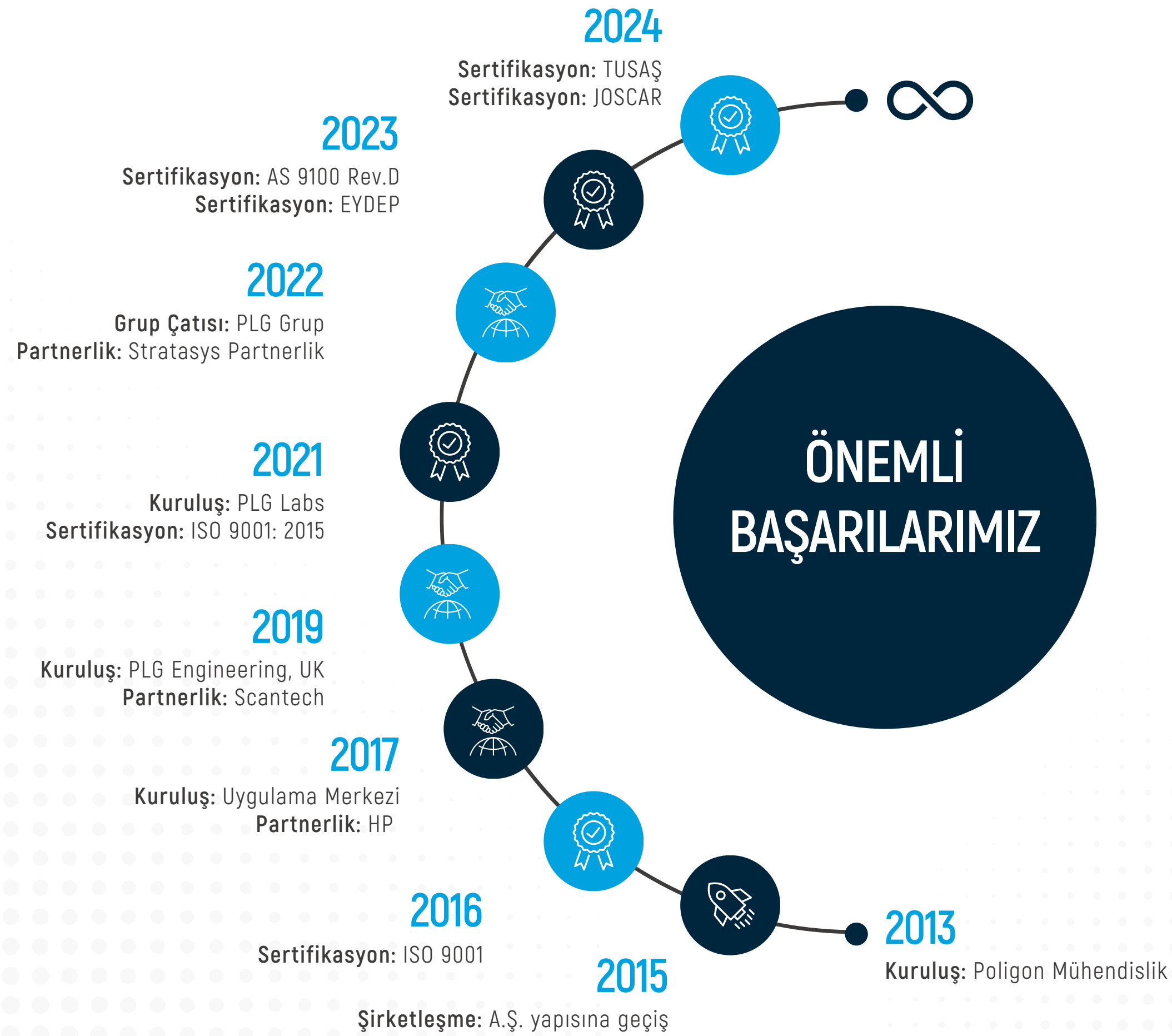

# Kalite Belgeleri & Sertifikalarımız



ISO 9001: 2015



AS 9100 Rev. D



EYDEP



TUSAŞ



JOSCAR

# Bize Güvenen İş Ortaklarımız



aselsan

BAYKAR

HAVELSAN

STM

TEI  
TUSAŞ MOTOR SANAYİİ A.Ş.  
TUSAŞ ENGINE INDUSTRIES, INC.

TFS  
TURKISH FUEL SERVICES

TÜRKHAVACILIK  
UZAYSANAYİİ

assanhanil



BRUSA

FARBA

farplas

fkt



GRAMMER



LUCID

MAGNA



MARTURFOMPAK  
INTERNATIONAL

McLaren

Mercedes-Benz

odelo  
Automotive Signal Lights

OYAK RENAULT  
OTOMOBİL FABRİKALARI

RedDOT  
CORPORATION

TOFAŞ  
TÜRK OTOMOBİL FABRİKASI A.Ş.

Togg

Valeo

beko

B/S/H/

Ferre

Haier

KORKMAZ

simfer

VESTEL

Wiser Tech

plg grup

poligon  
mühendislik  
Link To The Future

PLG  
Engineering

plg labs

## Ürünlerimiz

HP  
Scantech  
Stratasys

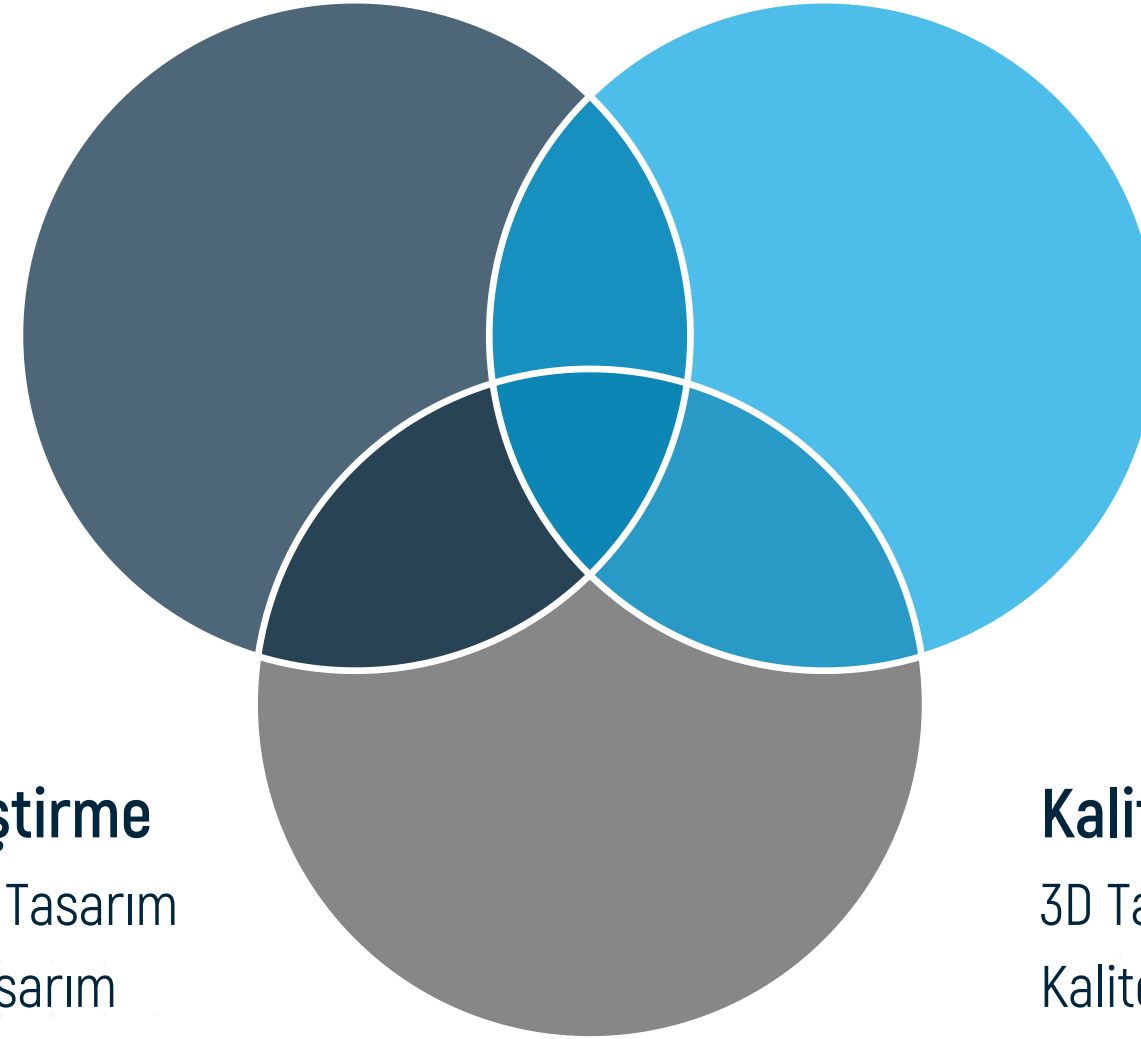

## Az Adetli İmalat

Eklemeli İmalat  
Hızlı Prototipleme  
Hızlı Kalıplama  
Talaşlı İmalat - CNC  
Ardıl İşlem

## Ürün Geliştirme

Endüstriyel Tasarım  
Mekanik Tasarım  
Tersine Mühendislik  
Analiz & Simülasyon  
Tesislerin Dijital İkizi

## Kalite Kontrol

3D Tarama  
Kalite Kontrol  
Raporlama  
Data Optimizasyonu  
Catia v5 CAD Modelleme



# Çalışma Alanlarımız

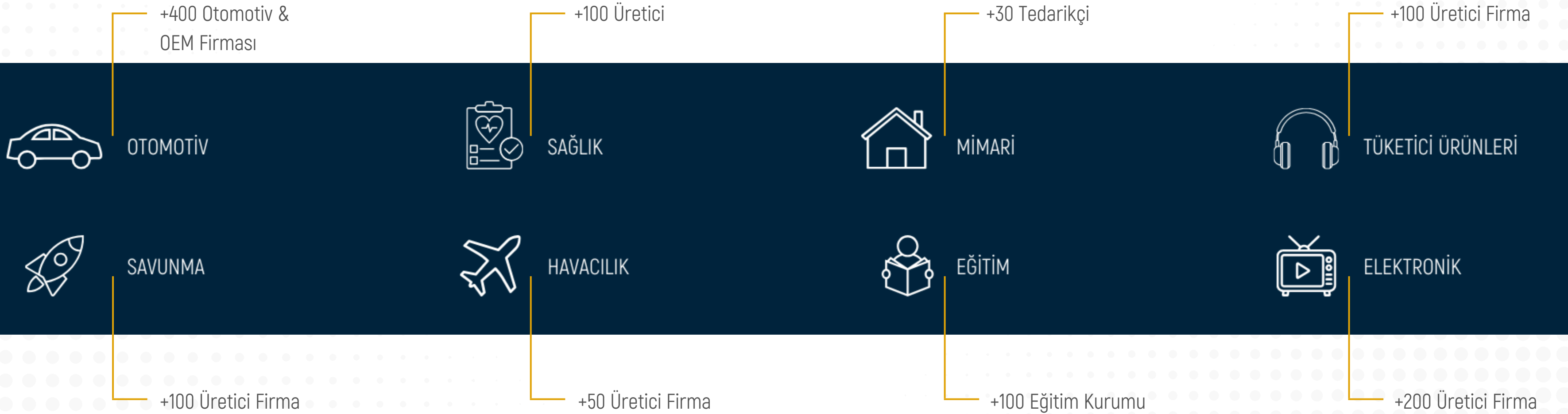



FDM® 3D Yazıcılar  
PolyJet 3D Yazıcılar  
P3™ 3D Yazıcılar  
Yazılımlar



HP Jet Fusion Endüstriyel 3D Baskı Çözümleri



3B Lazer Tarama Sistemleri  
Kalite Kontrol Yazılımları

## Eklemeli İmalat



**Makine:** HP Jet Fusion 4200  
**Üretim Hacmi:** 380x284x380mm



**Makine:** Stratasys F770  
**Üretim Hacmi:** 1000x610x610mm



**Makine:** Stratasys Fortus 450mc  
**Üretim Hacmi:** 406x355x406mm



**Makine:** Stratasys Origin® One  
**Üretim Hacmi:** 192x108x370mm

## Talaşlı İmalat - CNC



**Makine:** 3 eksen CNC  
**İşleme Hacmi:** 1060x600x560mm

## Hızlı Kalıplama



**Makine:** Vakum PU Döküm Makinesi  
**Döküm Kapasitesi:** 1,5 kg



**Makine:** RIM PU Döküm Makinesi  
**Döküm Kapasitesi:** 3,5 kg

## Yazılım

SolidCAM  
SolidWorks  
CatiaV5  
GeomagicsDesignX  
GeomagicsControlX  
PolyWorks  
Magics RP  
GrabCAD  
Z-Suit  
AutoDeskNetFabb

# Başarı Hikayelerimiz - Otomotiv



OTOMOTİV



SAĞLIK



MİMARİ



TÜKETİCİ ÜRÜNLERİ



SAVUNMA



HAVACILIK



EĞİTİM



ELEKTRONİK

## Fonksiyonel Prototip İmalatı

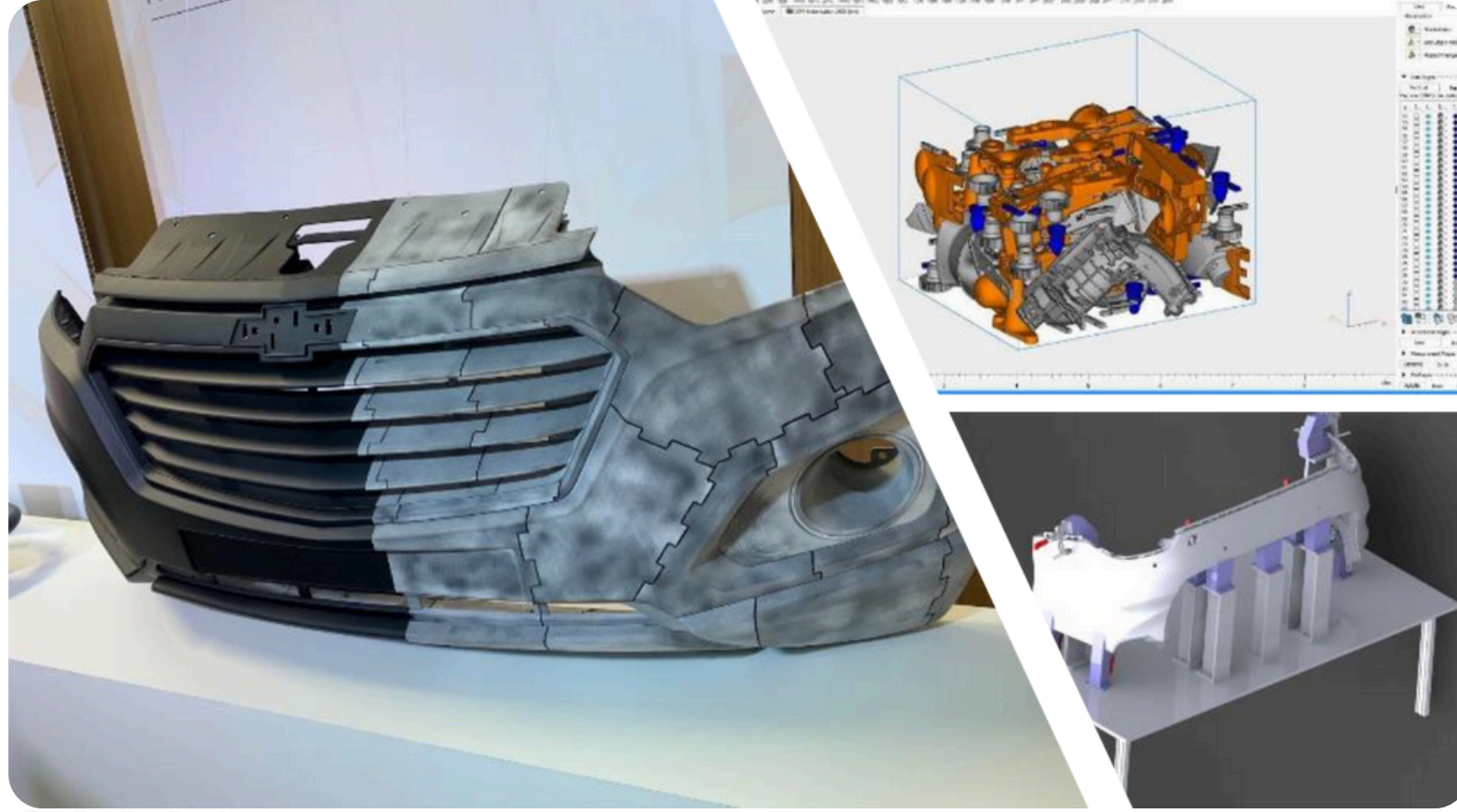

Chevrolet Ön Tampon

- DFAM çalışması
- Fikstür tasarım ve imalatı
- Birleştirme teknoloji seçimi
- Yüzey İşlem ve Boya



Chevrolet Ön Konsol

Chevrolet

## F-Max Aksesuar Parçaları

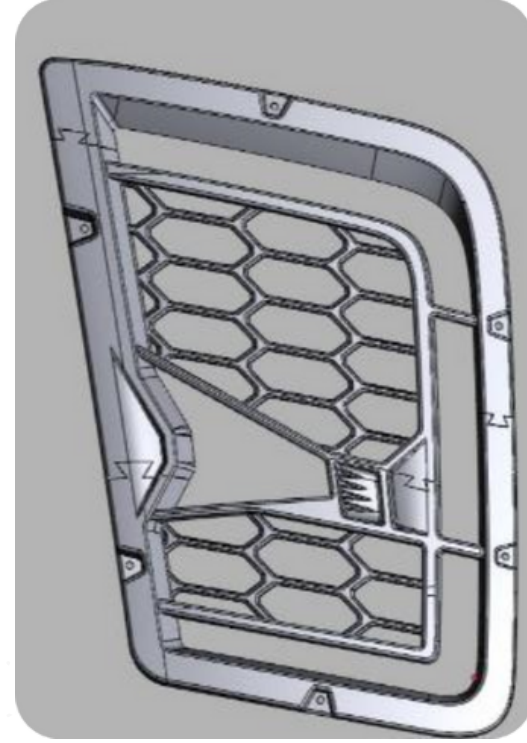

- Gerçek malzeme ile üretim
- Yüzey İşlem
- Krom kaplama
- Yerinde montaj desteği
- 9 günde üretim

- 3D tasarım
- DFAM çalışması
- Parçalı Üretim için özel kesim teknikleri
- Eklemeli İmalat ile üretim
- Yüzey İşlem ve Boya
- Teslim Süresi: 36 saat



FORD

## Az Adetli Son Kullanım Parçaları



- Silikon Kalıplama ile üretim
- Fonksiyonel parçalar
- 180 adet üretim
- Yüzey işlem ve boya
- 18 hafta süre kazancı
- €40K kalıp tasarrufu

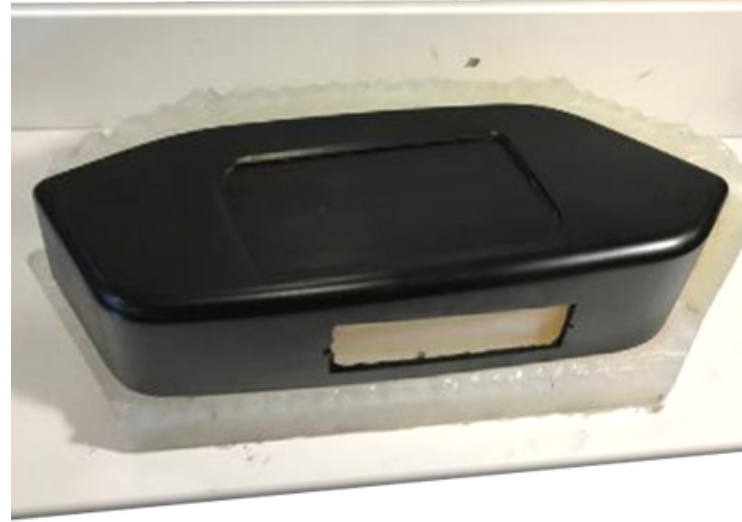

- Prototip Kalıp İmalatı
- Enjeksiyon kalıbı öncesi fonksiyonel test parçaları
- Tekrarlanabilir hassasiyet
- 200 adet parça üretimi
- Serigrafi ve yüzey işlemleri
- Teslimat süresi 7-10 iş günü
- 24 hafta proje takviminden tasarruf



# Başarı Hikayelerimiz - Savunma



OTOMOTİV



SAĞLIK



MİMARİ



TÜKETİCİ ÜRÜNLERİ



SAVUNMA



HAVACILIK



EĞİTİM



ELEKTRONİK



## Az Adetli Fonksiyonel Prototip

- 3D Tarama
- Tersine Mühendislik
- Modüler Tasarım
- DFAM
- Orijinali ile aynı ağırlık ve ağırlık merkezi
- Kırılmaz
- Yüzey işlem ve boya
- 20 adet üretim

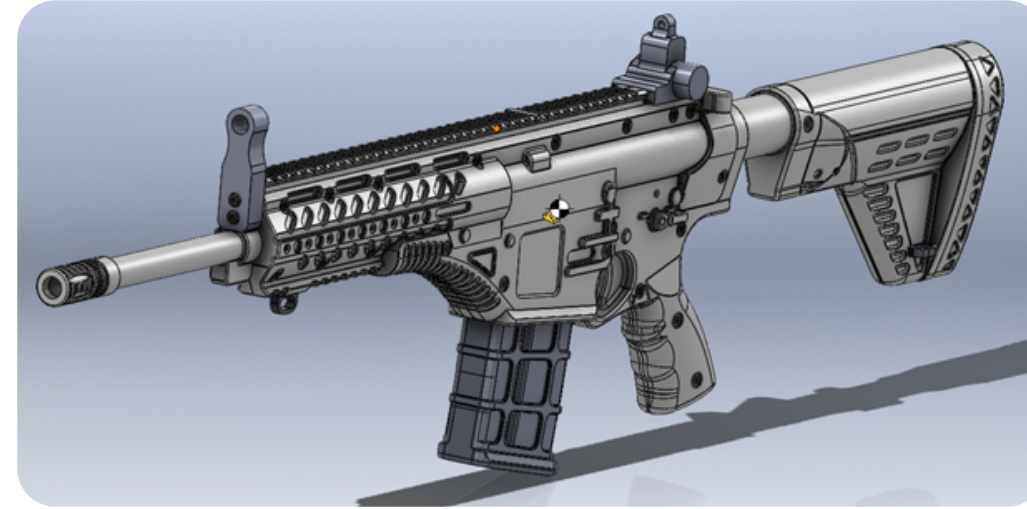

ÜRGE Projesi: Havelan-MPT76-Eğitim Tüfeği

# Başarı Hikayelerimiz - Sağlık



OTOMOTİV



SAĞLIK



MİMARİ



TÜKETİCİ ÜRÜNLERİ



SAVUNMA



HAVACILIK



EĞİTİM



ELEKTRONİK

## DENTAL - İmplant Tasarımı ve Üretimi

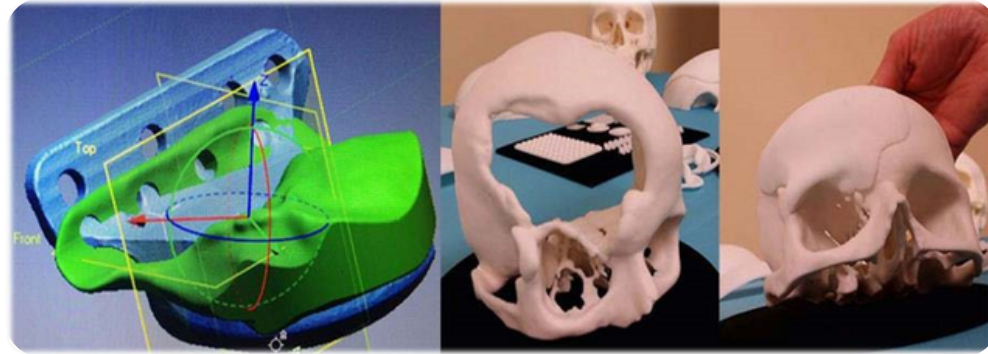
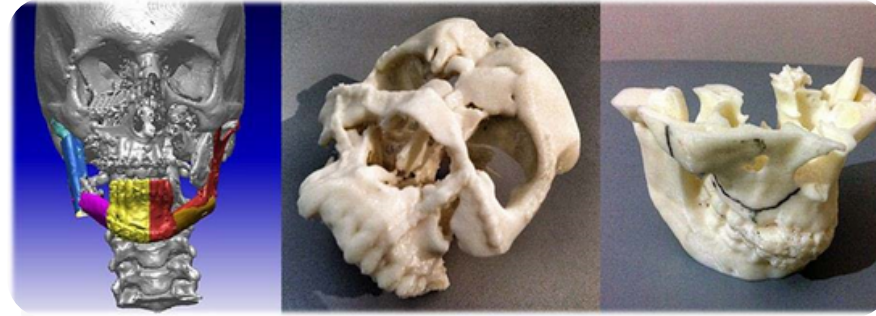

- 1 günde hızlı tasarım
- Her müşteriye özel tasarım
- 3D CT data ile çalışma
- Metal 3D printer ile titanyum baskı



- Ayakları olmayan martı için protez ayak üretimi
- 3D tarama ve tasarım
- Silikon kalıplama ile üretim

## ORTEZ & PROTEZ - Martı Protez Ayak

# Başarı Hikayelerimiz - Havacılık



OTOMOTİV



SAĞLIK



MİMARİ



TÜKETİCİ ÜRÜNLERİ



SAVUNMA



HAVACILIK



EĞİTİM



ELEKTRONİK

## Fonksiyonel Prototip

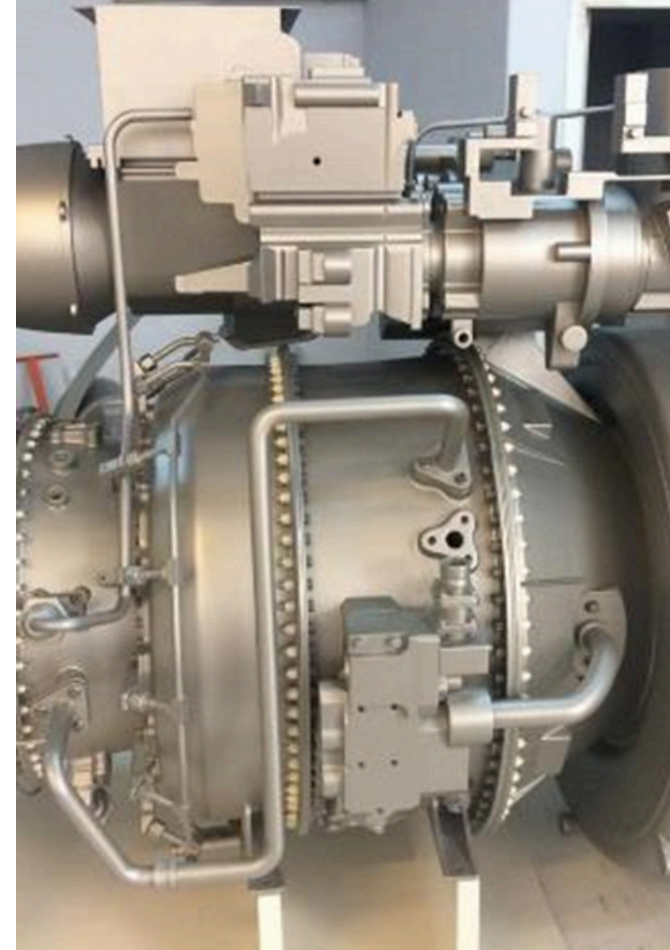
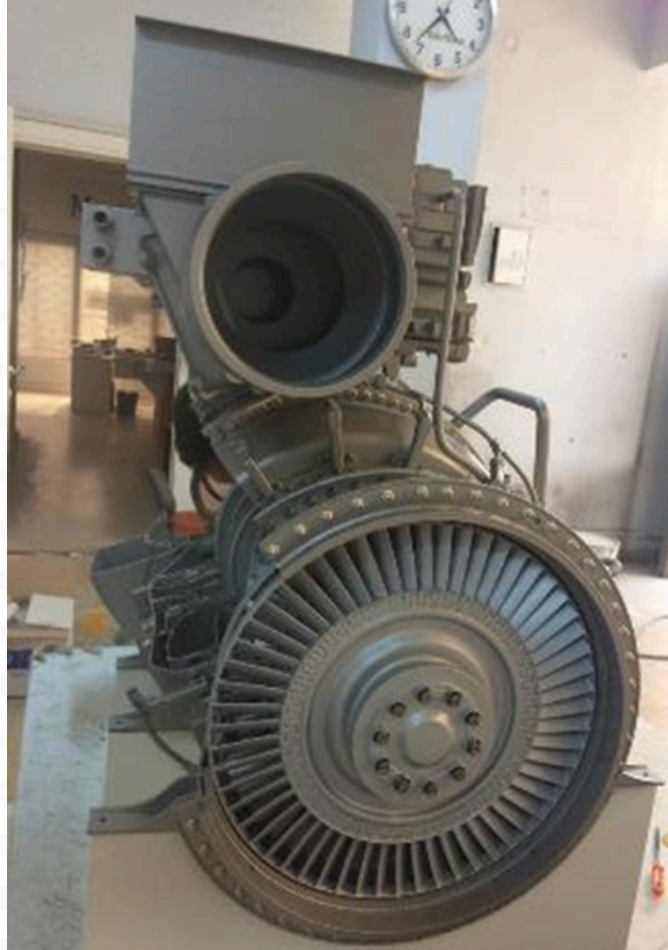

- DFAM
- Eklemeli İmalat ile üretim
- Yüzey işlem ve boya
- Montaj

## TEİ - Fonksiyonel Turbo Şaft Motoru Mock-Up

## Büyük Kamyon Tarama ve Maket Üretimi

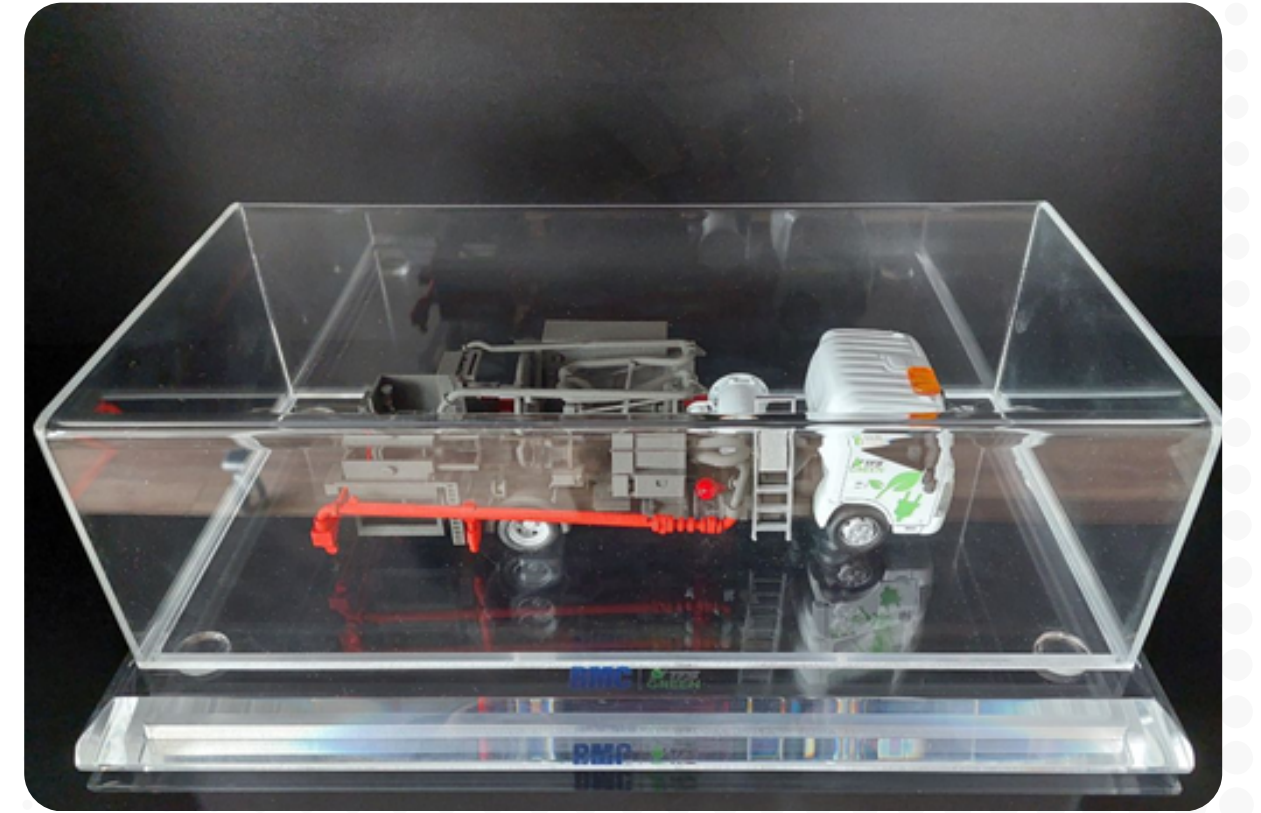

- 8 m uzunlukta kamyon 3B Tarama
- Tarama Süresi: 5 saat
- $\pm 0,1$  Hassasiyet
- DFAM
- Eklemeli İmalat ile Üretim
- Yüzey İşlem ve Boyama
- Montaj



Tarama ve Modelleme

İmalat

TFS Akaryakıt

# Başarı Hikayelerimiz - Tüketici Ürünleri



OTOMOTİV



SAĞLIK



MİMARİ



TÜKETİCİ ÜRÜNLERİ



SAVUNMA



HAVACILIK



EĞİTİM



ELEKTRONİK

## Az Adetli Fonksiyonel Prototip



- Endüstriyel Tasarım
- Seri İmalata Uygun Mekanik Tasarım
- Hızlı Kalıplama İle İmalat
- Yüzey İşlem ve Boya
- 50 % daha ekonomik, 400 % daha hızlı proje yönetimi

ÜRGE Projesi: POS Cihazı Tasarım ve Üretimi





Global vizyonu olan bir  
mühendislik firmasıyız



Ortaklarımızla güçlü  
bağlar kurarız

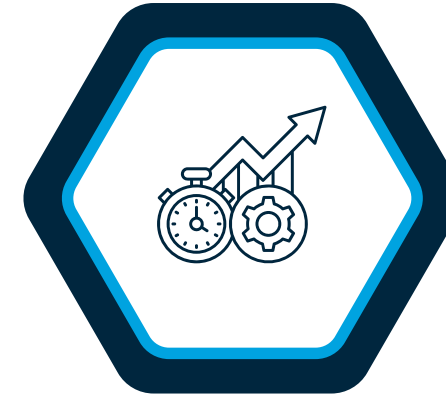

Sıkı çalışırız



Sıra dışı bir  
tedarikçiyiz



Yalnızca hizmetini  
verdiğimiz, güvendiğimiz  
ürünleri satarız



Çalışanlarımızı özenle  
seçeriz



3D teknolojileri adımız gibi  
biliriz



Biz ancak sizinle «BİZ»  
olabiliriz

# Bize Ulařın

## PLG Grup – İstanbul Ofis

Atatürk Mah. Dudullu Cad. Gülay Sok. No: 5  
Poligon Plaza Ataşehir – İSTANBUL

☎ 0 (216) 471 82 82

## PLG Grup – Bursa Ofis

Çalı Mah. Ahıska Cad. No: 215  
Nilüfer– BURSA

☎ 0 (224) 441 14 82



[www.poligonmuhendislik.com](http://www.poligonmuhendislik.com)



[info@poligonmuhendislik.com](mailto:info@poligonmuhendislik.com)



PLG Grup ile  
Yarına Liderlik  
Etmeye Hazır Ol!

 plg grup

 plg grup

 poligon  
mühendislik  
Link To The Future

 PLG  
Engineering

 plg labs